



Pompe centrifughe di media portata per piccole e medie applicazioni agricole. Dotate di girante aperta per consentire il passaggio di piccoli corpi solidi (Ø max. 10 mm.).

Medium delivery centrifugal pumps for small and medium agricultural applications. Open impeller which allows small solid items to pass through (Ø max 10 mm.).

Bombas centrifugas de caudal mediano para aplicaciones agrícolas pequeñas y medianas. Dotadas de rodete abierto para permitir el paso de pequeños cuerpos sólidos (Ø máx. 10 mm).

Pompes centrifuges de débit moyen pour petites et moyennes applications agricoles. Elles sont munies d'une roue ouverte afin de permettre le passage de petits corps solides (Ø max. 10 mm.).

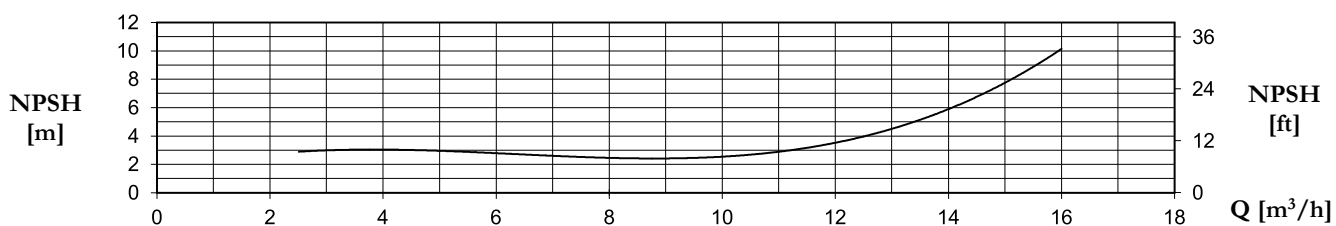
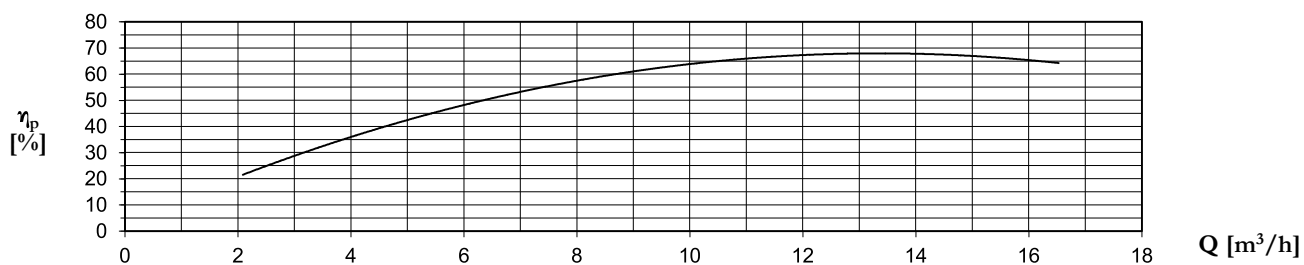
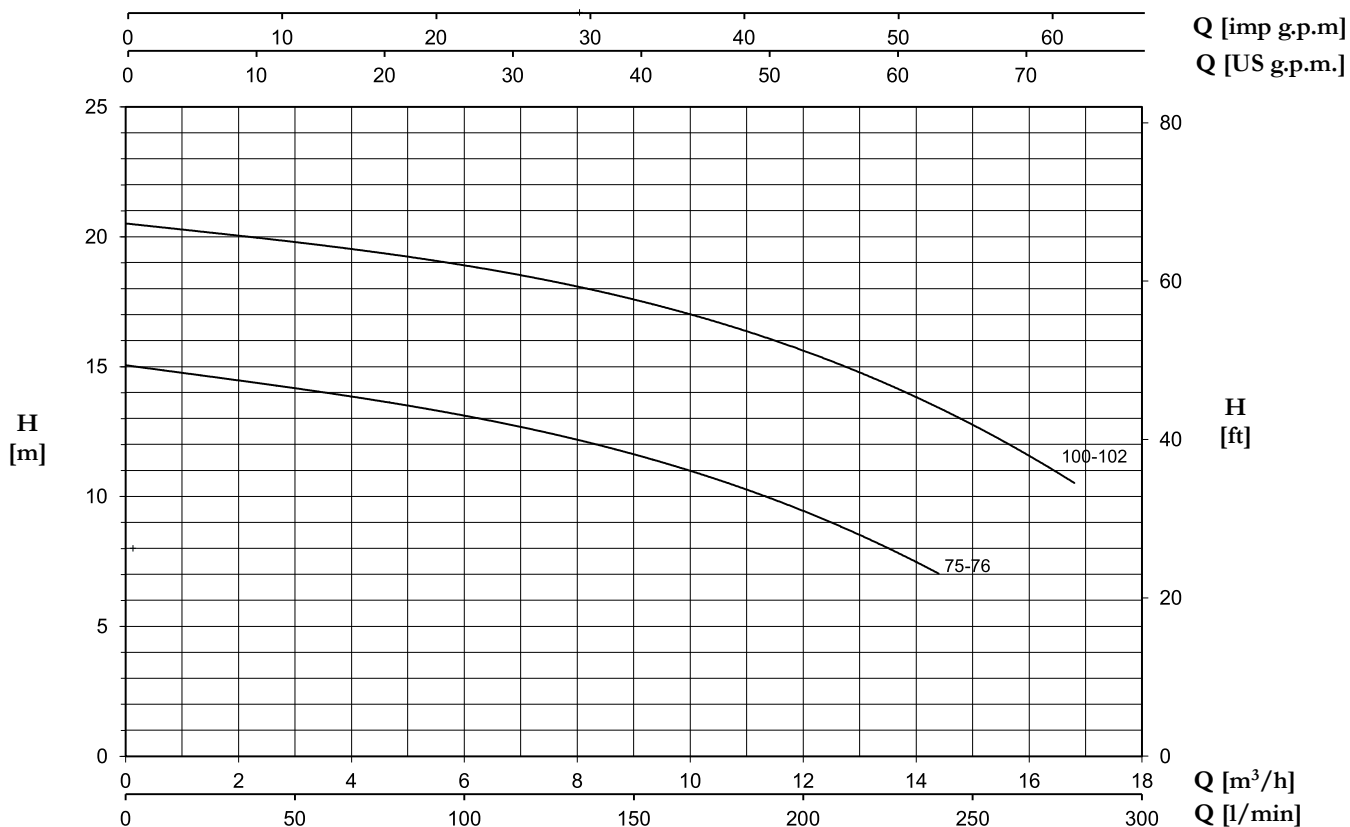

CARATTERISTICHE COSTRUTTIVE / CONSTRUCTION FEATURES CARACTERÍSTICAS CONSTRUCTIVAS / CARACTÉRISTIQUES D'EXÉCUTION

Corpo pompa	ghisa
Pump body	cast iron
Cuerpo bomba	fundición
Corps de pompe	fonte
Supporto motore	ghisa
Motor bracket	cast iron
Soporte motor	fundición
Support moteur	fonte
Girante	Noryl® o ottone
Impeller	Noryl® or brass
Rodete	Noryl® o latón
Turbine	Noryl® ou laiton
Tenuta meccanica	ceramica-grafite
Mechanical seal	ceramic-graphite
Sello mecánico	cerámica-grafito
Garniture mécanique	céramique-graphite
Albero motore	acciaio AISI 416
Motor shaft	stainless steel AISI 416
Eje motor	acero AISI 416
Arbre moteur	acier AISI 416
Temperatura del liquido	girante Noryl®: 0 - 50 °C girante ottone: 0 - 90 °C
Liquid temperature	Noryl® impeller: 0 - 50 °C brass impeller: 0 - 90 °C
Temperatura del líquido	rodete de Noryl®: 0 - 50 °C rodete latón: 0 - 90 °C
Température du liquide	turbine en Noryl®: 0 - 50 °C turbine laiton: 0 - 90 °C
Pressione di esercizio	
Operating pressure	max 6 bar
Presión de trabajo	
Pression de fonctionnement	
MOTORE / MOTOR / MOTOR / MOTEUR	
Motore 2 poli a induzione	3~ 230/400V-50Hz
2 pole induction motor	1~ 230V-50Hz
Motor de 2 polos a inducción	(con termoprotettore with thermal protection con protección térmica avec protection thermique)
Moteur à induction à 2 pôles	
Classe di isolamento	
Insulation class	F
Clase de aislamiento	
Classe d'isolation	
Grado di protezione	
Protection degree	IP44
Grado de protección	
Protection	

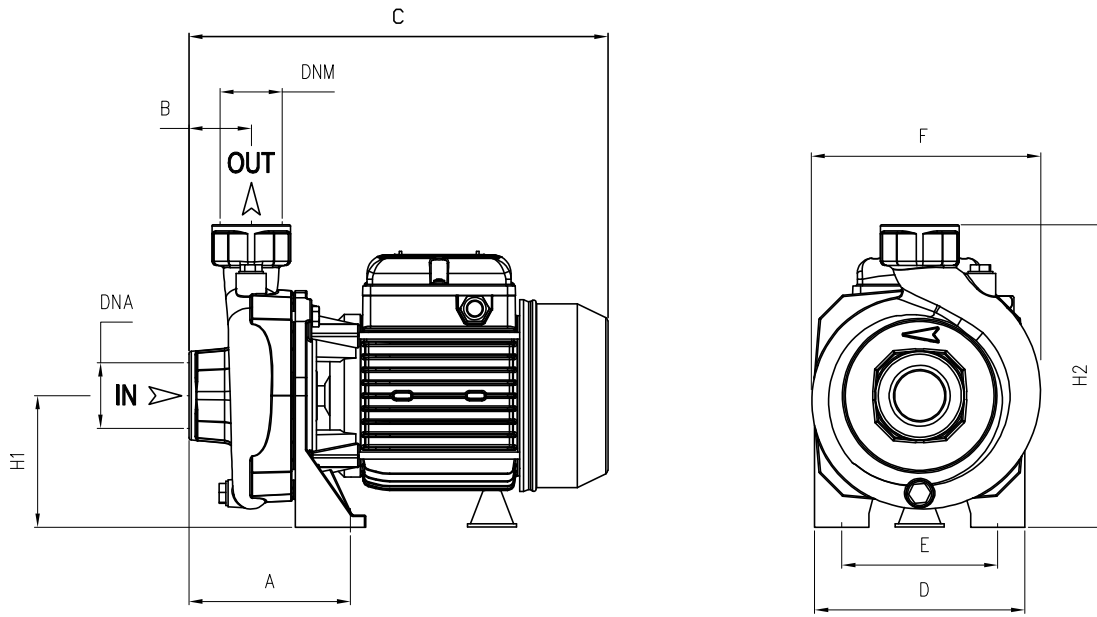

TYPE		P2		P1 (kW)		AMPERE		Q (m³/h - l/min)						
1~	3~					1~	3~	0	3	6	9	12	14,4	16,8
		(HP)	(kW)	1~	3~	1x230V 50 Hz	3x400V 50 Hz	H (m)						
CR 75/76	CRT 75/76	0,8	0,59	0,73	0,83	3,4	1,5	15,0	14,3	13,0	11,6	9,5	7,0	-
CR 100/102	CRT 100/102	1	0,74	1,14	1,20	5,3	2,4	20,5	19,8	18,9	17,7	15,5	13,5	10,5



TYPE	DIMENSIONS (mm)													
	A	B	C	D	E	F	H1	H2	DNA	DNM	I	L	M	
CR 75	120	45	308	155	115	170	97	222	1"1/2 G	1"1/4 G	325	200	265	13
CR 76	120	45	308	155	115	170	97	222	1"1/2 G	1"1/2G	325	200	265	13
CR 100	120	45	308	155	115	170	97	222	1"1/2 G	1"1/4 G	325	200	265	14
CR 102	120	45	308	155	115	170	97	222	1"1/2 G	1"1/2 G	325	200	265	14

TYPE				
	TRUCK		CONTAINER	
	PALLET (cm)	N° pumps	PALLET (cm)	N° pumps
CR	85x110x145	65	85x110x195	91